

Narzędzia ogrodowe

Łopaty węglowe

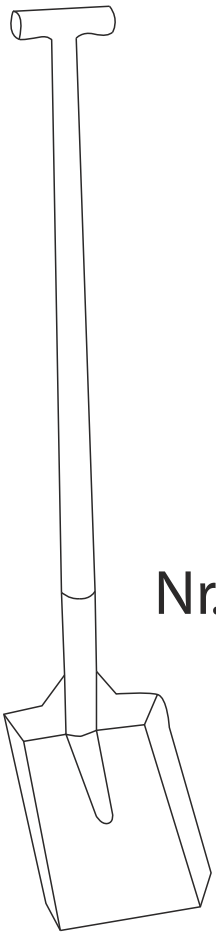

Nr. 1

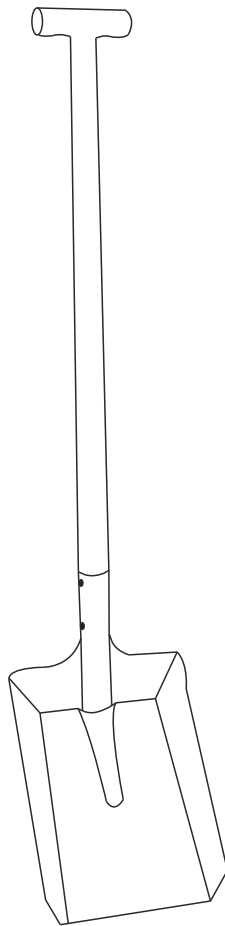

Nr. 2

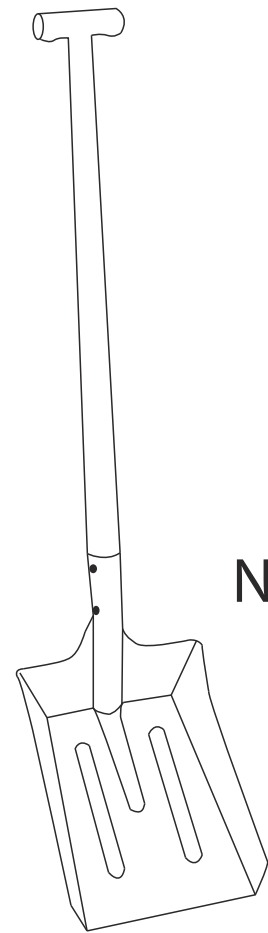

Nr. 3

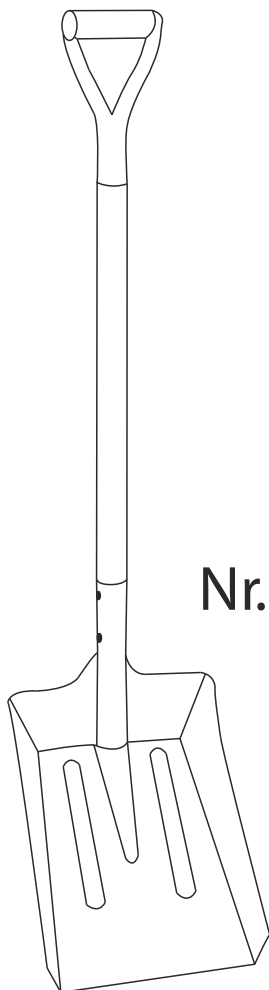

Nr. 4

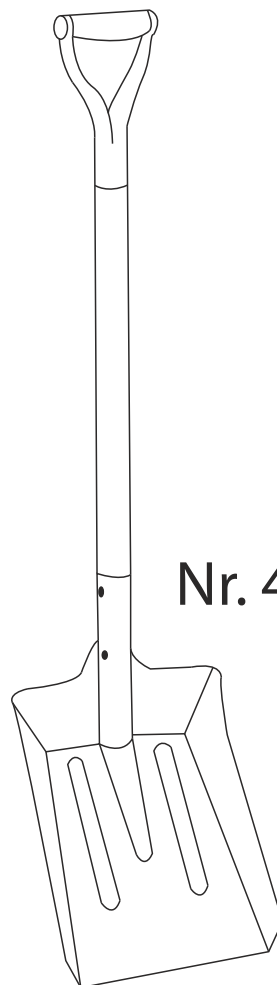

Nr. 4 Aluminiowa

Szpadle

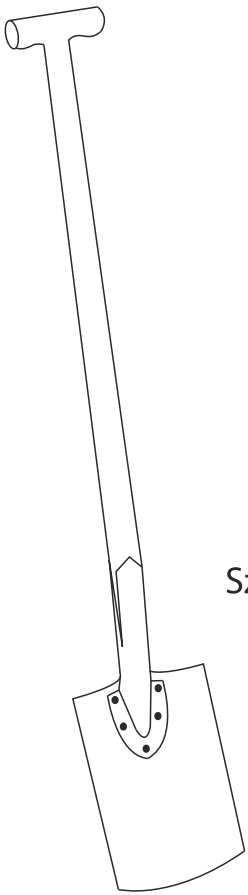

Szpadel metalowy
z nakładką

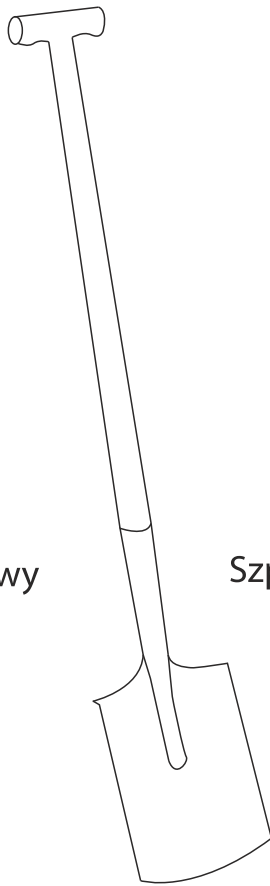

Szpadel metalowy
bez nakładką

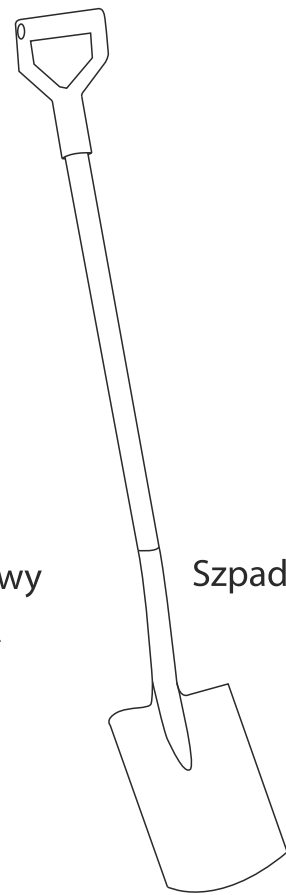

Szpadel metalowy

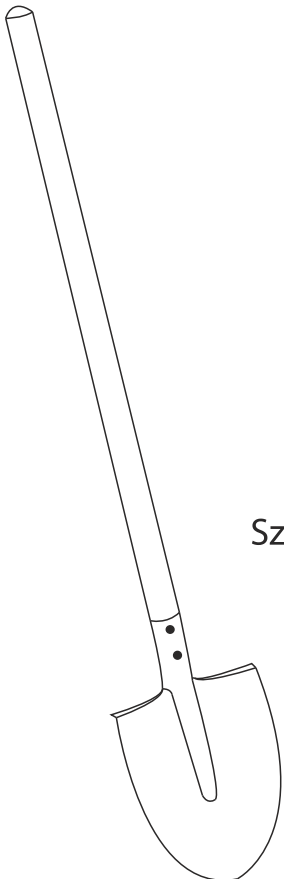

Szpadel ogrodowy
szpiczasty

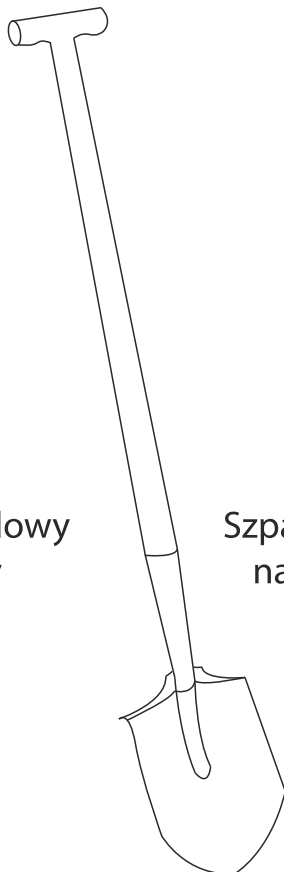

Szpadel ogrodowy bez
nakładki szpiczasty

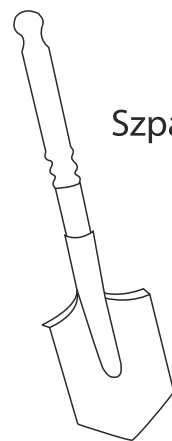

Szpadel saperka

Łopaty piaskowe

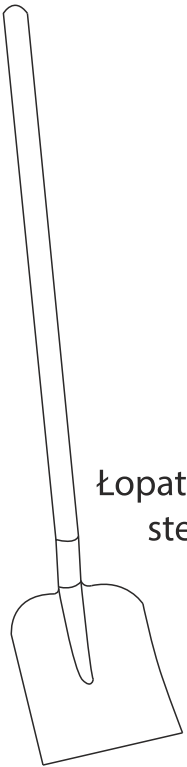

Łopata piaskowa
stal prosty

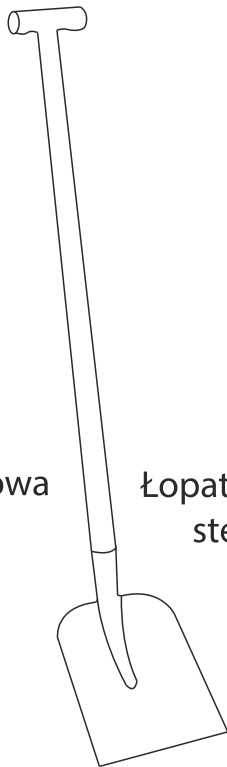

Łopata piaskowa
stal teowy

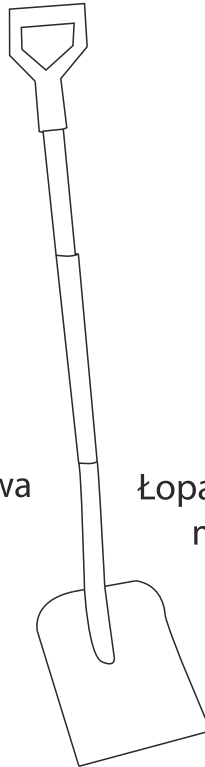

Łopata piaskowa
metalowa

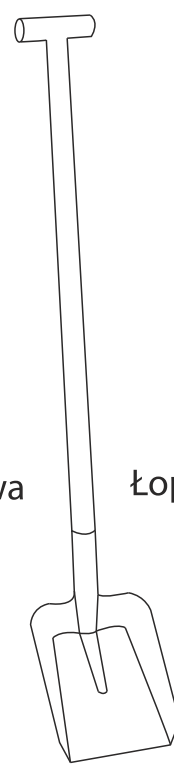

Łopata piaskowa
głęboka

Łopaty do śniegu

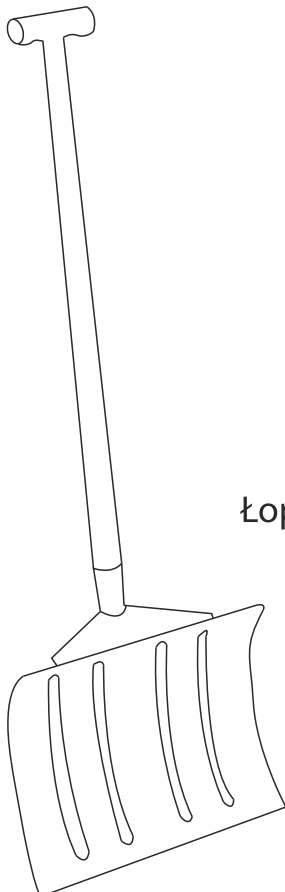

Łopata do śniegu
metalowa

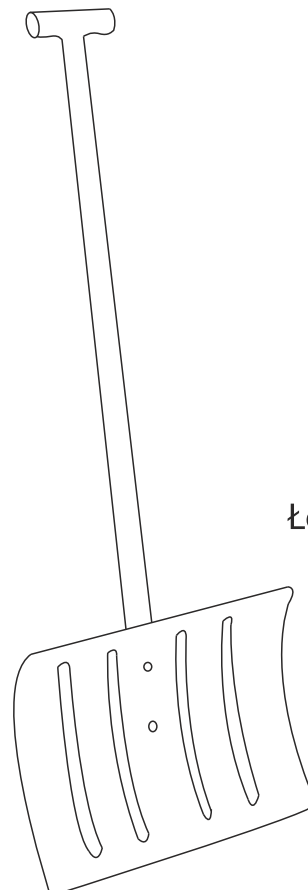

Łopata do śniegu
aluminiowa

Śmietniczki

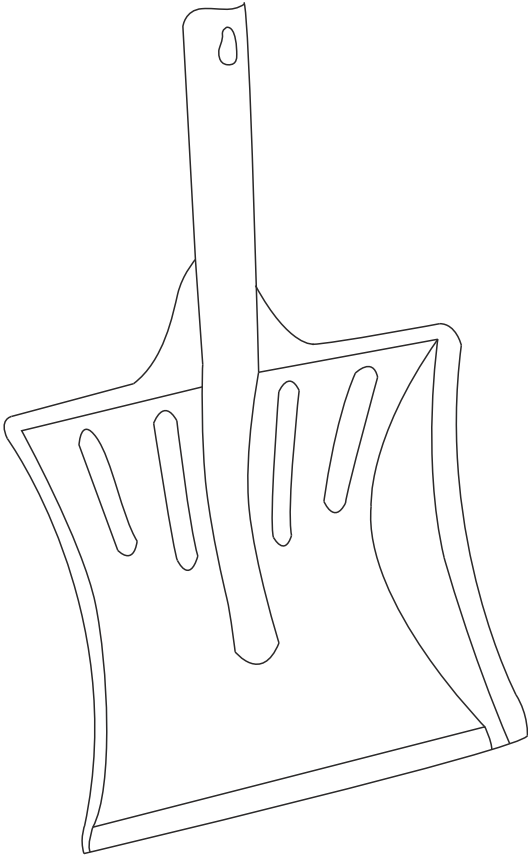

Śmietniczka metalowa

Śmietniczka ocynkowana
z rączką drewnianą

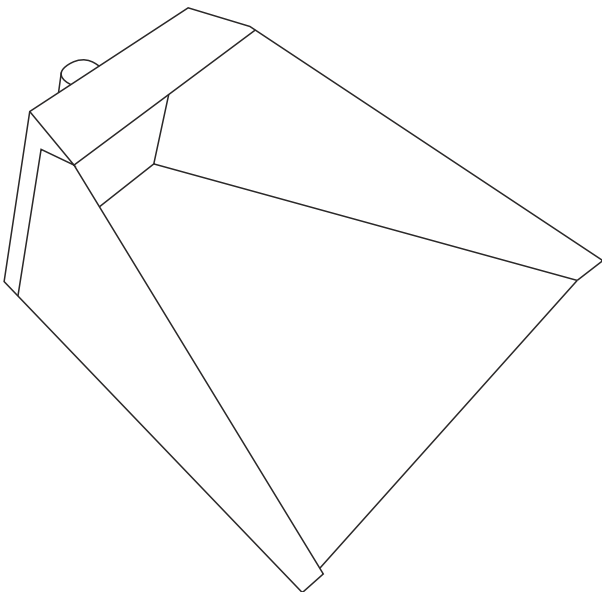
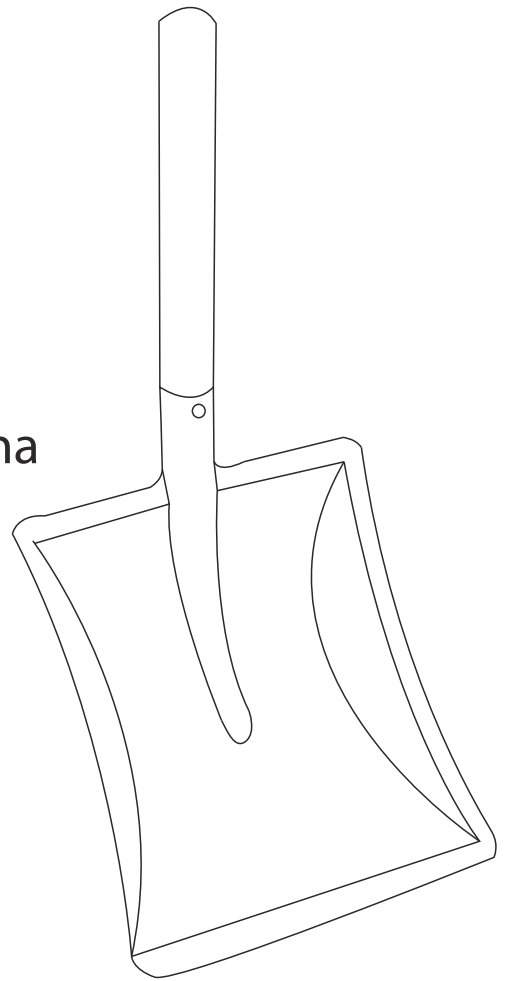

Śmietniczka „Lieniuch”

Inne wyroby

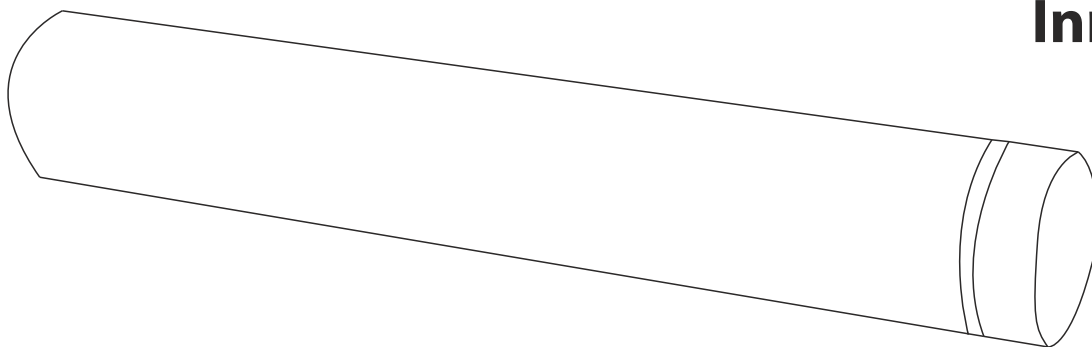

Rura z blachy, felcowana

średnica 100, 110, 120, 125, 130,
140, 150, 160, 180, 200 mm

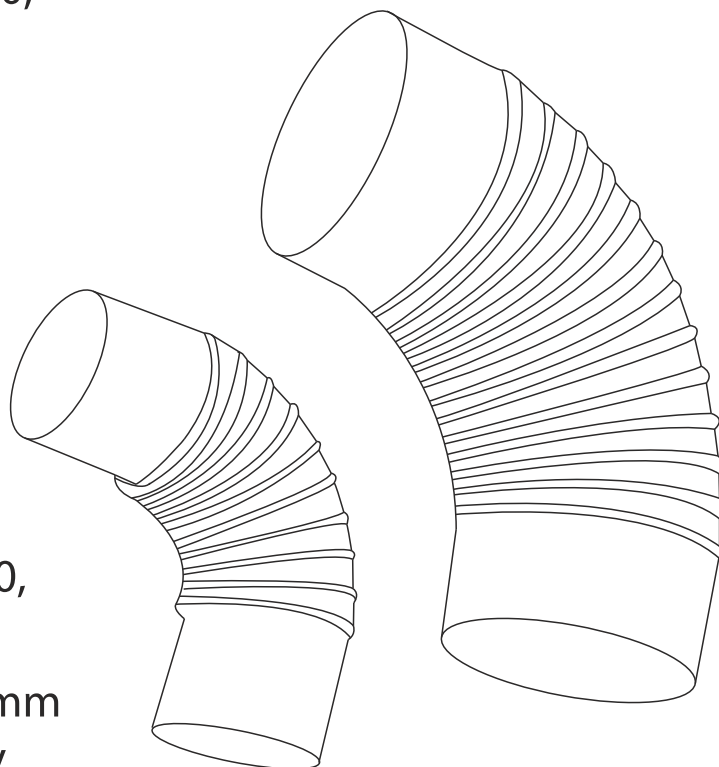

Kolanko karbowane

średnica 100, 110, 120, 125, 130,
140, 150, 160, 180, 200 mm

na życzenie klienta kolano 200mm
może być wykonane z blachy
0,8mm lub 1,0mm

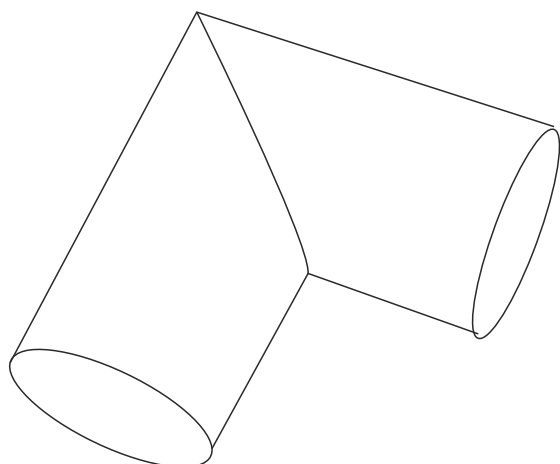

Kolanko kątowe

średnica 100, 110, 120, 130, 150 mm